



Evaluation Electronics

For Metrology Applications

www.heidenhain.com/readouts

For many metrology applications, ranging from simple measuring stations to complex inspection systems with multiple measuring points, HEIDENHAIN supports you with compatible evaluation electronics.

Their functionality is always oriented toward the specific application. Whether for an SPC inspection station, profile projector, or measuring microscope, the HEIDENHAIN **evaluation electronics for metrology applications** are the right choice for your measurement tasks.

Digital readouts from HEIDENHAIN

for manual machine tools optimally support the operator with cycles for milling, drilling and turning. You can find these digital readouts on the Internet at www.heidenhain.com or in the *Digital Readouts and Linear Encoders for Manually Operated Machine Tools* brochure.



Evaluation electronics for measurement and inspection tasks

Further information:

Comprehensive descriptions of all available interfaces as well as general electrical information are included in the *Interfaces of HEIDENHAIN Encoders* brochure (ID 1078628-xx).

For the required cables, please refer to the *Cables and Connectors* brochure (ID 1206103-xx).

You can download the operating instructions in the desired language free of charge from the HEIDENHAIN homepage.

This brochure supersedes all previous editions, which thereby become invalid. The basis for ordering from HEIDENHAIN is always the brochure edition valid when the order is placed.

Standards (ISO, EN, etc.) apply only where explicitly stated in the brochure.

Table of contents

Overview		
	Selection guide for measurement and inspection tasks	4
Specifications		
Measurement and inspection tasks	GAGE-CHEK 2000 evaluation unit for demanding measured-value acquisition	6
	GAGE-CHEK 4000 SW evaluation software for reliable 1D measured-value acquisition	10
	ND 280 evaluation unit for simple measuring and positioning tasks	14
	ND 287 evaluation unit for measuring and inspection stations	16
	EIB 700 signal converter for computer-aided measured-value acquisition	18
	IK 220 signal converter for computer-aided measured-value acquisition	20
Mounting		
Dimensions and installation	GAGE-CHEK 2000	22
	Accessory: adapter connectors	24
	Accessory: external operating element	24
	ND 200	25
	EIB 700	26
	Electrical connection	
Interfaces	Overview	27
	Optional assemblies for the ND 287	28
	Switching inputs/outputs on the ND 287	29
	EIB 700 and IK 220 signal converters	31
	EIB application software for the EIB 700	33
	Encoder inputs	34

Selection guide

Measurement and inspection tasks

	Screen	Axes		Functions	Options/Additional functions	Model	Page
		Length	Angle				
GAGE-CHEK 2000 Evaluation unit for <ul style="list-style-type: none"> Positioning equipment Measuring fixtures Adjustment and inspection equipment 	Color touchscreen	3 (adjustable)		<ul style="list-style-type: none"> Acquisition of precise measured values, and spot-on positioning in metrology applications 100 presets Dial gage: comparison of the displayed value with nominal value, warning threshold, and tolerance threshold Measurement series with minimum and maximum value recording Difference of minimum and maximum values (range) Measurement of master parts (mastering) Data transfer either manually, continuously, or triggered by touch probe or switching function Diameter/radius display Relative measurement Probing functions: edge, centerline, and circle User administration Configurability of each axis for length or angle display Coupled axis for sum measurement or differential measurement 	–	GC 2013	6
						GC 2023	
						GC 2093	
						GC 2013 I/O	
GAGE-CHEK 4000 SW Evaluation software for <ul style="list-style-type: none"> Reliable measured-value acquisition 	PC screen	8 (adjustable)		<ul style="list-style-type: none"> Configurability of each axis for length or angle display Measurement series with recording of minimum and maximum values Simple switching of the counting direction LOG function for Excel 	–	Software	10
ND 200 Evaluation unit for <ul style="list-style-type: none"> Measurement equipment Adjustment and inspection equipment SPC inspection stations Simple infeed and positioning tasks 	Monochrome	1 (adjustable)		–	–	ND 280	14
	Color	2 (adjustable)		Metrological and statistical functions (sorting and tolerance checking, measurement series, SPC)	Second encoder for sum/difference display, temperature compensation	ND 287	16
EIB 700 Signal converter for computer-aided measured-value acquisition on <ul style="list-style-type: none"> Measuring machines Inspection stations Multi-gauging fixtures Mobile data acquisition 	PC screen	4 (adjustable)		<ul style="list-style-type: none"> Precise position measurement; updating rate of up to 50 kHz Programmable measured-value inputs Internal and external measured-value triggers Measured-value memory for typically 250 000 measured values per channel Standard Ethernet interface connection to higher-level computer systems 	Mounting bracket for 19-inch systems	EIB 741 EIB 742	18
IK 220 Signal converter as a PCI slot card for computer-aided measured-value acquisition on measuring and inspection stations	PC screen	2 (adjustable)		<ul style="list-style-type: none"> Programmable measured-value inputs Internal and external measured-value triggers Measured-value memory for 8192 measured values per channel 	Assemblies for encoder outputs and external inputs/outputs	IK 220	20



GAGE-CHEK 2000



GAGE-CHEK 4000 SW



ND 287



EIB 700



IK 220

GAGE-CHEK 2000

Evaluation unit for demanding measured-value acquisition

The GAGE-CHEK 2000 evaluation unit is particularly well suited for positioning tasks on positioning, measuring, adjustment, and inspection equipment, as well as for the retrofitting of measuring machines in order to collect and transmit data to a PC.

Design

Thanks to its rugged industrial design, the GAGE-CHEK 2000 is superbly suited for applications in measuring rooms and harsh production environments. Its slim aluminum housing, featuring an integrated power adapter and fanless passive cooling system, is exceptionally sturdy and resilient. The unit's straightforward touchscreen, made of specially hardened glass, supports multi-touch gesture control and permits operation with gloves.

Functions

The logical arrangement of menus and function elements provides intuitive user guidance, which supports you while using the different functions. Along with the typical functionality of an evaluation unit, such as zero resetting and preset setting, the GAGE-CHEK 2000 also offers the following practical features:

- Dial gage for a graph of the measured value
- Measurement series with minimum and maximum value recording
- Measurement of master parts (mastering)
- Coupled axis for sum measurement or differential measurement
- Probing functions
- Manual, continuous, touch-probe-triggered, or switching-function triggered measured value output

Data transmission

Over the data interfaces, you can transfer the captured measured values to a PC. The GAGE-CHEK 2000 supports RS-232 (with an adapter) and Ethernet data transmission. For data transmission via Ethernet we support the MQTT and REST network protocols.

Remote access

The GAGE-CHEK 2000 offers various possibilities for remote access:

- Switching functions
- Position-dependent switching functions
- RS-232 serial interface
- Ethernet



Intuitive display

All of the information you need is displayed in a clean and easy-to-read format on the unit's high-resolution, 7-inch screen. Only those functions that are actually available within a given context and situation are shown. The self-explanatory operating elements provide intuitive user guidance.

Configurable axis names

The axis names shown in the display can be changed to meet the requirements of the given application. By means of an alias assignment, you can easily change the names of the X, Y, and Z axes. The axis names may contain any combination of up to two letters and/or numbers.

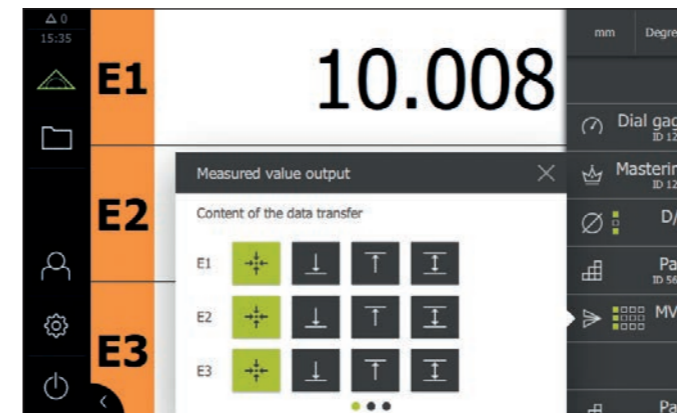

GAGE-CHEK 2013



GAGE-CHEK 2013 I/O

	GAGE-CHEK 2013 GAGE-CHEK 2013 I/O	GAGE-CHEK 2023	GAGE-CHEK 2093
Axes	Up to three axes		
Encoder interface	~ 1 V _{PP} , ~ 11 μA _{PP} , EnDat 2.2	□TTL	1 connection: □TTL 2 connections: ~ 1 V _{PP} , ~ 11 μA _{PP} , EnDat 2.2
Input frequency	~ 1 V _{PP} : ≤ 400 kHz ~ 11 μA _{PP} : ≤ 150 kHz	≤ 5 MHz	~ 1 V _{PP} : ≤ 400 kHz ~ 11 μA _{PP} : ≤ 150 kHz □TTL: ≤ 5 MHz
Subdivision factor	4096-fold (only with 1 V _{PP})		
Display step	Adjustable, max. 8 digits <i>Linear axes XYZ:</i> Down to 0.00001 mm <i>Angular axis Q:</i> Down to 0.00001° (00° 00' 00.1")		
Display	7-inch screen (15:9) for multitouch operation; resolution: WVGA 800 x 480 pixels for dialog boxes, input fields, position values, and graphing functions		
Functions	<ul style="list-style-type: none"> Acquisition of precise measured values, and spot-on positioning in metrology applications 100 presets Dial gage for a graph of the measured value Measurement series with minimum and maximum value recording Difference of minimum and maximum values (range) Measurement of master parts (mastering) Data transfer either manually, continuously, or triggered by touch probe or switching function Diameter/radius display Relative measurement Probing functions (edge, centerline, and circle) User administration Configurability of each axis for length or angle display Coupled axis for sum measurement or differential measurement 		
Error compensation	<ul style="list-style-type: none"> Linear (LEC) and segmented linear (SLEC) using up to 200 compensation points Squareness calibration; matrix compensation (NLEC) using up to 99 x 99 points 		
Data interface	1x Ethernet 100 Mbit/1 Gbit (RJ45); 1x Hi-Speed USB 2.0 (Type A)		
Other connections	Foot switch for two functions		
Accessories	Multi-Pos, Duo-Pos, and Single-Pos stands, Multi-Pos holder, power cable, adapter connector, foot switch		
Grid connection	AC 100 V to 240 V (±10%); 50 Hz to 60 Hz (±5%), ≤ 38 W		
Operating temperature	0 °C to +45 °C (storage temperature: -20 °C to +70 °C)		
Protection EN 60529	IP65; back panel: IP40		
Mounting	Multi-Pos, Duo-Pos, or Single-Pos stand; Multi-Pos holder; 50 mm x 50 mm mounting hole pattern		
Mass	GC 2013, GC 2023, GC 2093: ≈ 1.3 kg GC 2013 I/O: ≈ 1.5 kg		

Connectivity of GC 2013, GC 2023, GC 2093 versus GC 2013 I/O

	GAGE-CHEK 2013 GAGE-CHEK 2023 GAGE-CHEK 2093	GAGE-CHEK 2013 I/O
Digital inputs		
TTL 0 V to 5 V	4	4
High DC 11 V to 30 V, 2.1 mA to 6.0 mA Low DC 3 V to 2.2 V, 0.43 mA	-	24
Digital outputs		
TTL 0 V to +5 V, maximum load = 1 kΩ	1	1
DC 24 V (20.4 V to 28.8 V); max.: 150 mA per channel	-	8
Relay outputs Max. switching voltage: AC/DC 30 V; max.: 0.5 A; max. 15 W; max. continuous current: 0.5 A	-	2
Analog inputs Voltage range: DC 0 V to 5 V Resistance range: 100 Ω ≤ R ≤ 50 kΩ	-	4
Analog outputs Voltage range: DC -10 V to +10 V Maximum load: 1 kΩ	-	4
5 V voltage outputs Voltage tolerance: ±5%; maximum current: 100 mA	-	1
Touch probe connection Voltage supply: DC 5 V or DC 12 V		
Digital inputs: TTL 0 V to 5 V (low active)	4	4
Digital outputs: TTL 0 V to 5 V, maximum load = 1 kΩ	1	1

GAGE-CHEK 4000 SW

Evaluation software for reliable 1D measured-value acquisition

The GAGE-CHEK 4000SW evaluation software is particularly suitable for positioning tasks on measuring and positioning equipment. Position values can be loaded directly to Excel using a LOG function.

Functions

The logical arrangement of menus and function elements provides intuitive user guidance, which supports you while using the different functions. Along with the typical functionality, such as zero resetting and preset setting, the GAGE-CHEK 4000 software also offers the following practical features:

- Configurability of each axis for length or angle display
- Measurement series with recording of minimum and maximum values
- Simple switching of the counting direction
- LOG function for Excel

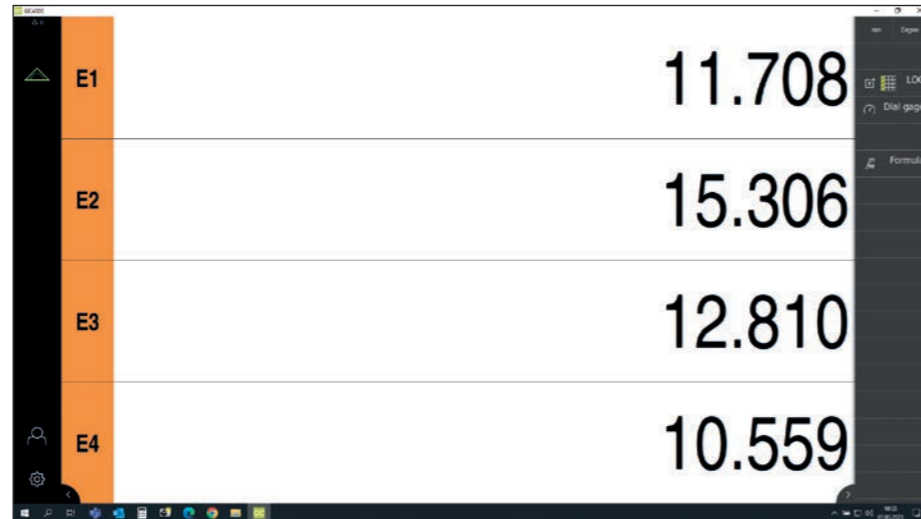

Clear overview

Only those functions that are actually available within a given context and situation are shown. The self-explanatory operating elements provide intuitive user guidance.



System requirements	GAGE-CHEK 4000 SW
Hardware interface	EIB 74x ¹⁾ (must be ordered separately from HEIDENHAIN; for more information, see www.heidenhain.com/products/signal-converters)
Encoder interfaces	1 Vpp, 11 µApp or EnDat 2.2
Operating system	Microsoft Windows 10 (version 1803 or higher)
Hard-disk space	≥ 250 MB
Screen resolution	≥ 1280 x 800 pixels
Microsoft Office	Excel 365 for LOG functions
License	Various license models are available for the software: <ul style="list-style-type: none"> • 1089223-01: Lifetime license • 1089224-01: Rental license (duration: anywhere from 1 month to 24 months) • 1089224-52: Trial license (free for 2 months)

¹⁾ The TCP port must be correspondingly enabled on the PC

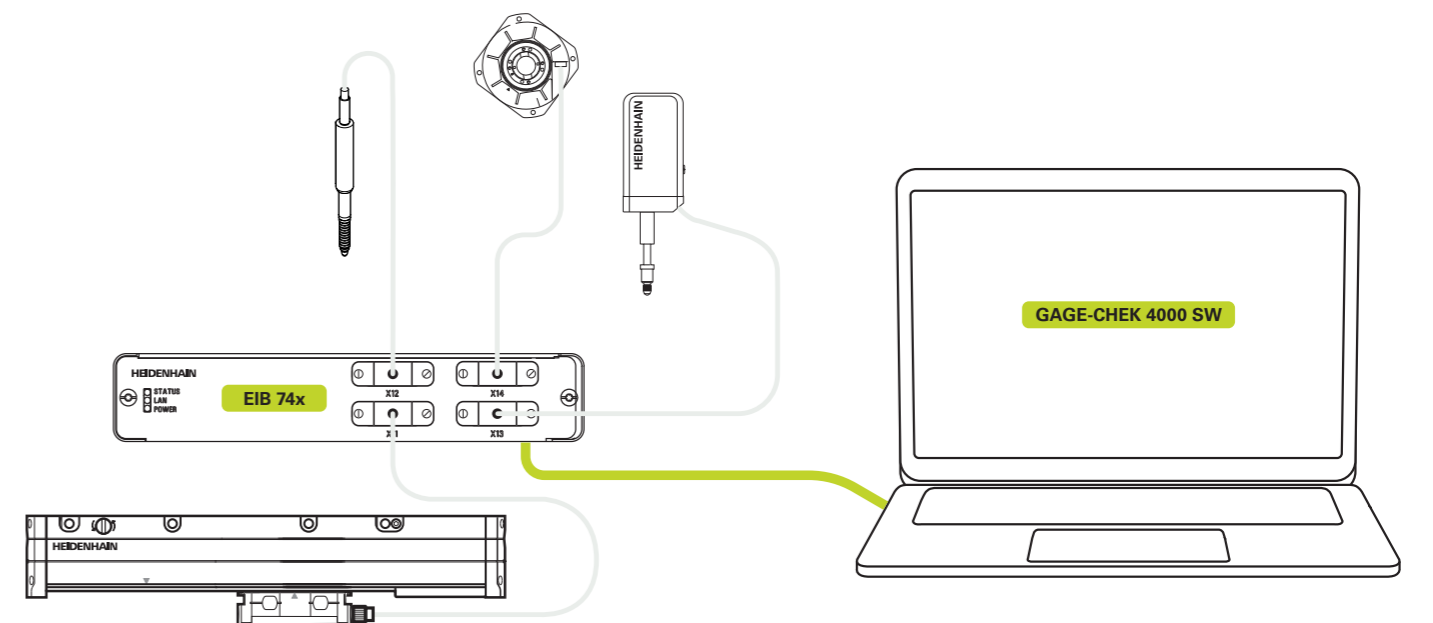

Connection of encoders through an EIB 74x

Microsoft and Excel 365 are registered trademarks of Microsoft Corporation.

Functions for GAGE-CHEK 2000 and GAGE-CHEK 4000SW

Configurable function elements

The functionality of the GAGE-CHEK can be adapted to the given requirements through individually configurable function elements in the Inspector view. Along with function elements for the output of measured values, functions such as a preset table and the storage of minimum and maximum values are available as well.

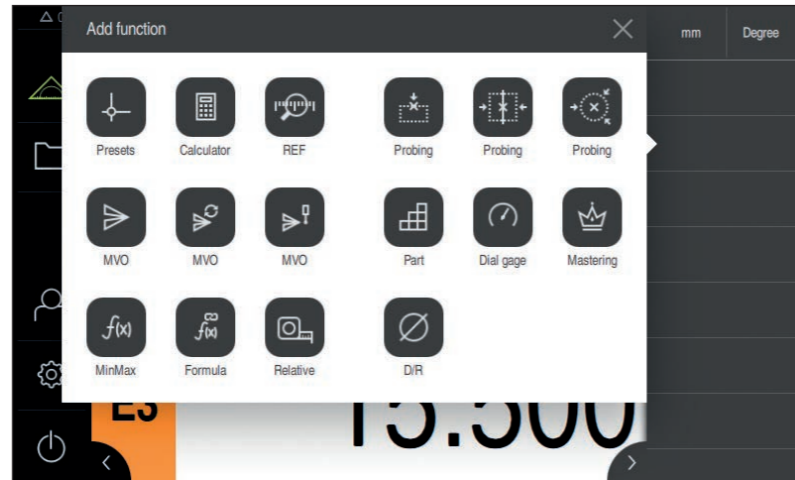

Recording minimum and maximum values (MinMax)

The GAGE-CHEK is equipped with a function for recording minimum and maximum values. This function can be configured for the axes as desired. The highest and lowest measured values of a measurement series, including their difference, are recorded and can be output over the data interface. This function is particularly advantageous for radial run-out inspection.

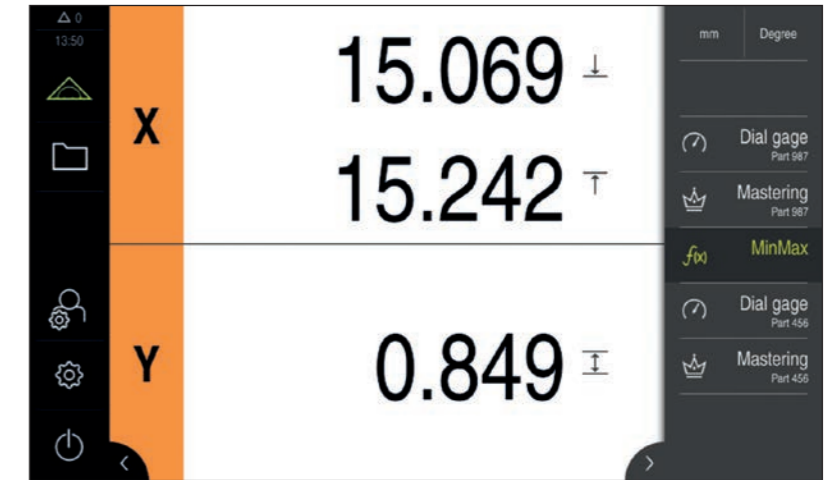

Dial gage

The dial gage function lets you make a direct comparison between the acquired measured values and the nominal value, warning limits, and tolerance limits. The measured values are shown as a graph in the form of a dial gage. For evaluation, the GAGE-CHEK supports you with a color depiction of a dial gage.

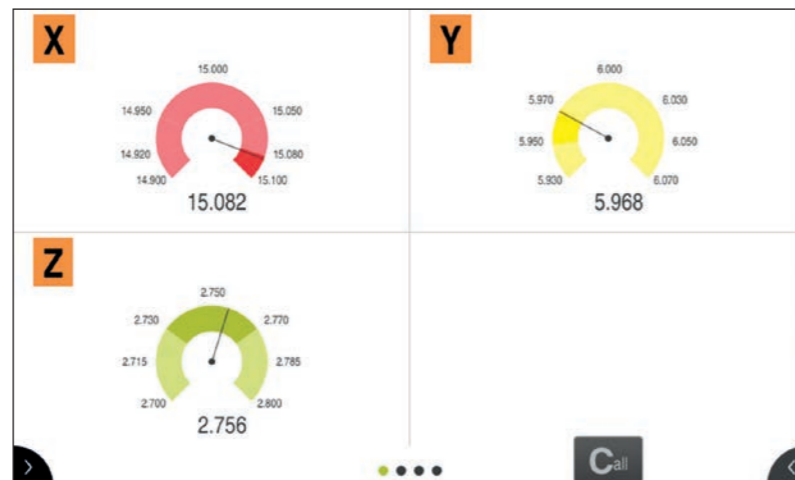

Configurable data formats for the measurement output

Along with providing a default format, the GAGE-CHEK also gives you the option of storing your own data formats for data transmission via RS-232. Thanks to the configurability of its data formats, the GAGE-CHEK is particularly effective as a data logger on retrofitted, manually operated measuring machines. The measured values are recorded by the GAGE-CHEK and then relayed to a connected PC for further processing.

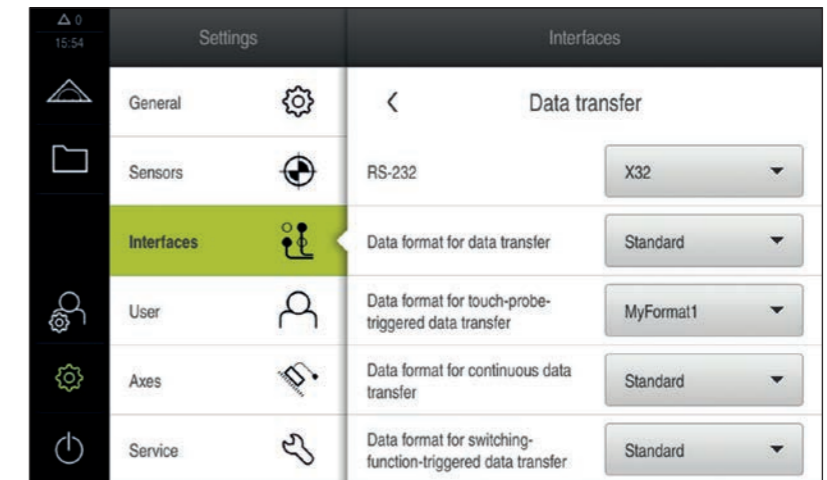

Formula calculations with position values

The Formula function programmed into the GAGE-CHEK offers various calculation operations. For example, the average value of all axes can be displayed or parallel axes can be combined.

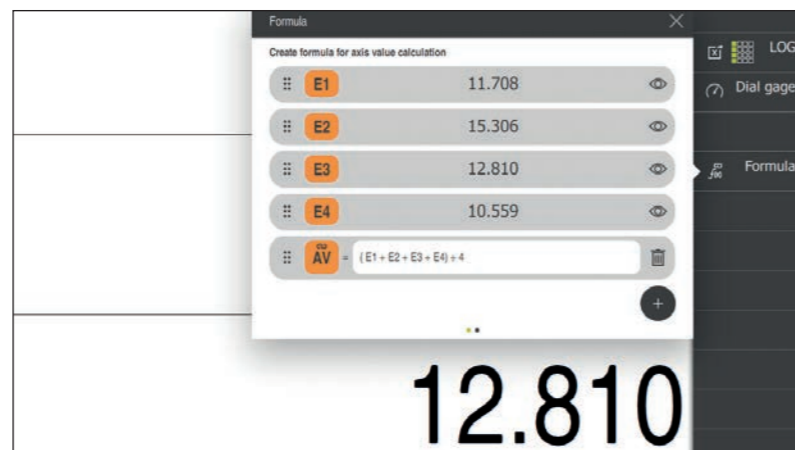

LOG function for Excel (for GAGE-CHEK 4000SW)

The GAGE-CHEK 4000SW software uses the LOG function to send the measured values directly to Excel 365 without requiring any additional software. Excel can then process the data further, for example in order to generate measurement series.

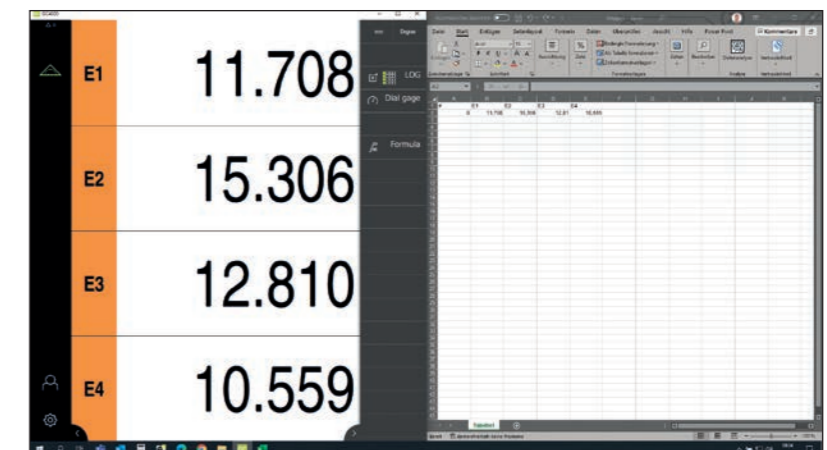

ND 280

Evaluation unit for simple measuring and positioning tasks

The ND 280 evaluation unit for one axis is suitable for measuring and inspection stations, as well as simple positioning tasks. The universal encoder input permits the connection of all incremental encoders with 11 μA_{PP} and 1 V_{PP} signals, and absolute encoders with the EnDat 2.2 interface from HEIDENHAIN.

Design

The ND 200 series features a sturdy aluminum die-cast housing. Its splash-proof, full-travel keyboard is built to handle shopfloor conditions. For displaying the measured values, a graphics-capable screen shows the status display and soft keys.

Functions

The **ND 280** digital readout provides all of the key functions for simple measuring and positioning tasks. Expanded functionality is offered by the ND 287 evaluation unit (e.g., for metrological acquisition and statistical analysis of measured values). Thanks to its switching inputs and outputs, the ND 287 can also be deployed in simple automated environments (see page 16).

Data interfaces

The ND 280 is equipped with serial interfaces for the transmission of measured values to a PC or printer, for the input/output of parameter lists and compensation value lists, and for diagnostics:
 USB
 RS-232-C/V.24



	ND 280
Axes	One
Encoder inputs	$\sim 1 V_{PP}$, $\sim 11 \mu A_{PP}$ or EnDat ¹⁾ : 15-pin D-sub (female, automatic interface detection)
Input frequency	$\sim 1 V_{PP}$: $\leq 500 \text{ kHz}$ $\sim 11 \mu A_{PP}$: $\leq 100 \text{ kHz}$
Subdivision factor	4096-fold
Display step ²⁾	Adjustable, max. 9 digits <i>Linear axis:</i> 0.5 μm to 0.002 μm <i>Angular axis:</i> 0.5° to 0.00001° or 00°00'00.1"
Display	Monochrome TFT screen Position values, dialog boxes, input fields, graphing functions, and soft keys
Status display	Operating mode, REF, preset, scaling factor, compensation, stopwatch, unit of measure, soft-key level
Functions	<ul style="list-style-type: none"> • REF reference-mark evaluation for distance-coded or single reference marks • Two presets • Distance-to-go mode • Integrated help and diagnostics • External operation via serial interface
Axis-error compensation	<i>Linear axis:</i> linear, and segmented linear via 200 compensation points <i>Angular axis:</i> segmented linear with 180 compensation points (every 2°)
Data interface	<ul style="list-style-type: none"> • RS-232-C/V.24 • USB (Type B)
Power connection	AC 100 V to 240 V (-15 % to +10 %), 48 Hz to 62 Hz; 30 W
Operating temperature	0 °C to 50 °C (storage temperature: -40 °C to 85 °C)
Protection EN 60529	IP40; front panel: IP54
Mass	$\approx 2.5 \text{ kg}$

¹⁾ Purely serial, with no evaluation of incremental signals

²⁾ Depends on the signal period of the connected encoder (Display step \approx Signal period/4096)

ND 287

Evaluation unit for measuring and inspection stations

Thanks to its extensive functionality, the ND 287 evaluation unit for one axis is well suited for measuring and inspection stations, and can also be used for simple positioning tasks. The universal encoder input permits the connection of all incremental encoders with 11 μA_{PP} and 1 V_{PP} signals, and absolute encoders with the EnDat 2.2 interface from HEIDENHAIN.

Design

The ND 287 features a sturdy aluminum die-cast housing. For displaying the measured values, a graphics-capable screen shows the status display and soft keys. Its splash-proof, full-travel keyboard is designed to handle the shop floor.

Functions

The ND 287 provides numerous functions for the metrological acquisition of individual values, including functions such as sorting and tolerance check mode, minimum and maximum value recording, and measurement series storage. Based on these data, mean values and standard deviations can be calculated and displayed in histograms or control charts. Thanks to its modular design, the ND 287 permits the connection of a second encoder for sum/difference measurement, or the connection of an analog sensor (e.g., for temperature compensation).

Data interfaces

The ND 287 is equipped with serial interfaces for the transmission of measured values to a PC or printer, for the input/output of parameter lists and compensation value lists, and for diagnostics:

- USB
- RS-232-C/V.24
- Ethernet 100BaseT (option)

The transmission of measured values can be initiated on the ND keyboard or via an external command. With RS-232-C/V.24, this is done using the software command CTRL+B or a configurable internal clock.

Sorting and tolerance checking

With the sorting and tolerance checking function of the ND 287, workpieces can be inspected for dimensional accuracy and sorted into classes. The result is shown through symbols in the color status display, with a corresponding signal applied at the switching outputs.

Display freeze

For readability, even during rapidly changing measured values, the display can be frozen with an external signal. The internal counter keeps on running.

Mathematical consideration of a second encoder

A second encoder or a sensor can be connected to the ND 287 through an optional **encoder module** or **analog module** input assembly. The data from the two encoders can be taken into account mathematically via operands. The result and the two measured values are saved. This opens up further areas of application, such as sum/difference display of two encoders or temperature compensation by means of a temperature sensor.

Recording and evaluating measurement series

The ND 287 provides a measured-value memory for the storage of measurement series. Alternatively, during the measurement series, the minimum, maximum, or difference can be displayed. The displayed value can also be checked for tolerance conformity with the sorting function. The saved measured values are evaluated and displayed in the following ways:

- Statistical view (mean value \bar{x} , standard deviation s , and range r)
- Diagram (graph of the measured values with minimum, maximum, and mean values, as well as tolerance limits)
- Measured value overview as a table

Statistical Process Control (SPC)

For SPC, the ND 287 saves up to 1000 measured values in its nonvolatile FIFO memory. Evaluation is performed with the following functions:

- Statistical view of the measured values in the FIFO memory
- Measured value overview as a table
- Diagram of the last 30 measured values
- Histogram in ten classes with probability density function and process capability indexes C_p and C_{pk}
- Control charts for mean value \bar{x} , standard deviation s , and range r

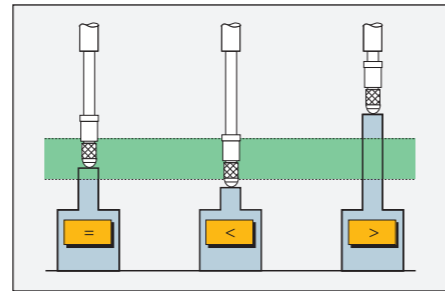

Sorting and tolerance checking

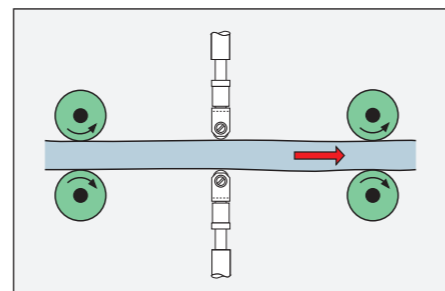

Sum measurement

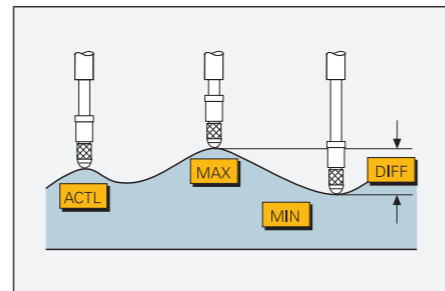

Measured value acquisition

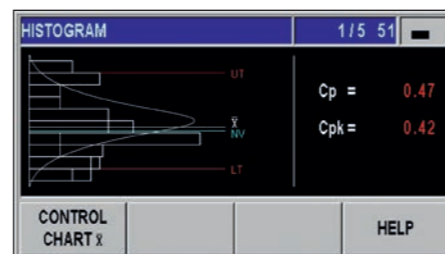

ND 287	
Axes	One; option: second input through encoder module
Encoder inputs	$\sim 1 \text{ V}_{\text{PP}}$, $\sim 11 \mu\text{A}_{\text{PP}}$ or EnDat ¹⁾ : 15-pin D-sub (female, automatic interface detection)
Input frequency	$\sim 1 \text{ V}_{\text{PP}}$: $\leq 500 \text{ kHz}$ $\sim 11 \mu\text{A}_{\text{PP}}$: $\leq 100 \text{ kHz}$
Subdivision factor	4096-fold
Display step ²⁾	Adjustable, max. 9 digits Linear axis: $0.5 \mu\text{m}$ to $0.002 \mu\text{m}$ Angular axis: 0.5° to $0.000 01^\circ$ ($00^\circ 00' 00.1''$)
Analog input	Option: $\pm 10 \text{ V}$ via analog module; resolution: 5 mV
Display	Screen for position values, dialog boxes, input fields, graphing functions, and soft keys
Functions	<ul style="list-style-type: none"> • REF reference-mark evaluation for distance-coded or single reference marks • Two presets and distance-to-go mode • External operation via serial interface • Sorting and tolerance checking • Measurement series with minimum and maximum value recording • Storage of measured values (up to 10 000) • Functions for statistical process control (SPC) • Graphical depiction of distribution/histogram • Sum/difference display (with second encoder module) • Thermal compensation (with analog module)
Axis-error compensation	Linear axis: linear, and segmented linear via 200 compensation points Angular axis: segmented linear with 180 compensation points (every 2°)
Data interface	RS-232-C/V.24; USB (Type B); option: Ethernet 100BaseT, via Ethernet module
Switching outputs for automation tasks	<ul style="list-style-type: none"> • Zero crossover; trigger points 1 and 2 • Sorting signals "<" and ">" • Errors
Switching inputs for automation tasks	<ul style="list-style-type: none"> • Zero reset, set displayed value • Move to reference point and ignore reference signals • Measured value output or display freeze • Start measurement series • Minimum, maximum, and difference display • Gating of the two encoder inputs • Sum or difference display • Display of measured value 1 or measured value 2
Accessories	Mounting adapter, encoder module, analog module, Ethernet module
Power connection	AC 100 V to 240 V (-15% to $+10\%$), 48 Hz to 62 Hz; 30 W
Operating temperature	0°C to 50°C (storage temperature: -40°C to 85°C)
Protection EN 60529	IP40; front panel: IP54
Mass	$\approx 2.5 \text{ kg}$

¹⁾ Purely serial, with no evaluation of incremental signals

²⁾ Depends on the signal period of the connected encoder (Display step \approx Signal period/4096)

EIB 700

Signal converter for computer-aided measured-value acquisition



For use as evaluation units, the EIB 700 signal converters feature connections for four encoders. These units are particularly well suited for the following applications:

- Precise position measurement, especially for inspection stations and multi-gauging fixtures
- Portable, on-site data acquisition (e.g., for machine calibration)
- Integration into customized applications (e.g., high-precision measuring machines)

The EIB 700 series is ideal for applications requiring high-resolution encoder signals and rapid measured-value acquisition. Its Ethernet transmission also enables the use of switches or hubs for connecting more than one EIB. Wireless LAN transmission, for example, can be used as well.

Design

The EIB 700 features a bench-top housing. With a mounting bracket accessory, it can also be easily installed into a 19-inch housing. The device is suitable for the following supply voltages:

EIB 741: AC 100 V to 240 V
EIB 742: DC 24 V

Functions

For **measured-value generation**, the EIB 700 subdivides the signal periods of the incremental signals up to 4096-fold. Automatic adjustment of the sinusoidal incremental signals reduces the error within one signal period.

The integrated **measured-value memory** enables the EIB 700 series to save typically 250 000 measured values per axis. Based on the axis, these measured values can be saved by means of either an internal or external trigger.

The **interval counter** permits position-dependent triggering in conjunction with an incremental encoder on Axis 1. For this purpose, the signals of Axis 1 are interpolated and forwarded to a position counter. Triggering pulses are generated either at a certain position or equidistantly at configurable intervals. They are continuously generated once a configurable starting position is crossed in either counting direction. The trigger pulses can be used to trigger further internal axes of the EIB or can also be output over a trigger output.

Data interface

A standard Ethernet interface using TCP/IP or UDP communication is available for **data output**, permitting direct connection to a PC, laptop, or industrial PC. The type of measured-value transmission can be selected through the operating mode (single values, as a block, or upon software request).

For **processing the measured values** on a PC, software drivers for Windows, Linux, and LabVIEW are included in delivery, as are example programs and the EIB application software. The software driver makes it easy to program customized applications, and the example programs demonstrate the potential of the EIB 700 series. The EIB application software assists with setting up and demonstrating the capabilities of the EIB 700 series. This software is provided as source code and can serve as a platform for the development of one's own applications.

Operating modes	Soft Real-Time	Recording	Streaming	Polling
Properties	Immediate transmission of the measured value upon occurrence of the triggering event	Storage of measured values in the EIB's internal measured-value memory	Buffering and block transmission of measured values	Software request originating from the customer's application
Selectable trigger sources	All internal and external sources			Via software command
Trigger rate	≤ 10 kHz (access time to position values < 100 μs)	≤ 50 kHz	≤ 50 kHz Up to 1 200 000 bytes/s	Depends on the application
Typical applications	Closed Loop control	Very high recording rate Offline data analysis	High recording rate in combination with high recording depth	Semi-static measured value recording

	EIB 741	EIB 742
Encoder inputs	15-pin D-sub connections (female, X11 to X14), for four encoders	
Interface (switchable)	~ 1 V _{PP} , ~ 11 μA _{PP}	EnDat 2.1 EnDat 2.2
Supply voltage for encoders	DC 5.12 V ±0.15 V; max. 450 mA per channel Overcurrent protection (automatic switch-off, resettable) at 550 mA	
Input frequency	≤ 500 kHz	– –
Subdivision factor	4096-fold	– –
Signal adjustment	Automatic adjustment of offset, phase, and amplitude	– –
Cable length ¹⁾	≤ 150 m	≤ 150 m ≤ 100 m
Data register for measured values	48 bits (of which only 44 bits are used)	
Interval counter	Derived from Axis 1 (only 1 V _{PP}) ²⁾ , Configurable interpolation factor from 1-fold to 100-fold Can be used as a trigger source or additional counting axis	– –
Measured-value memory	Typically 250 000 position values per channel	
Measured-value trigger ³⁾	Storage of the measured values of the four axes through an external or internal trigger (selectable). External: <ul style="list-style-type: none"> • Signal via trigger input • Software command (over Ethernet) Internal: <ul style="list-style-type: none"> • Timer and interval counter • Reference pulse of the respective axis (from Axis 1 and other axes) 	
Trigger input ⁴⁾	9-pin D-sub connection (male); differential inputs as per RS-485 (terminating resistors can be activated)	
Trigger output ⁴⁾	9-pin D-sub connection (female); four differential outputs as per RS-485	
Access to measured values	Depends on the selected operating mode (see separate table)	
Software	<ul style="list-style-type: none"> • Software drivers for Windows, Linux and LabVIEW • Example programs • EIB application software 	
Data interface ⁵⁾	Ethernet as per IEEE 802.3 (10/100/1000 Mbit/s)	
Network address	Automatic assignment through Dynamic Host Configuration Protocol (DHCP), or manual assignment	
Dimensions	Approx. 213 mm x 152 mm x 42 mm	
Operating temperature	0 °C to 45 °C (storage temperature: 0 °C to +70 °C)	
Supply voltage	EIB 741: AC 100 V to 240 V (±10 %), 50 Hz to 60 Hz (±2 %); max. power consumption: 30 W EIB 742: DC 24 V (–15 %/+20 %), max. 2 A	

¹⁾ The supply voltage range of the encoder must be maintained; specified cable length applies when HEIDENHAIN cables are used.

²⁾ Maximum input frequency during referencing: 70 kHz

³⁾ Different trigger sources can be assigned to the individual axes

⁴⁾ Can also be used as logical input or output

⁵⁾ The quality of the data cable between the EIB and PC must be adapted to the transmission rate and cable length

IK 220

Signal converter for computer-aided measured-value acquisition

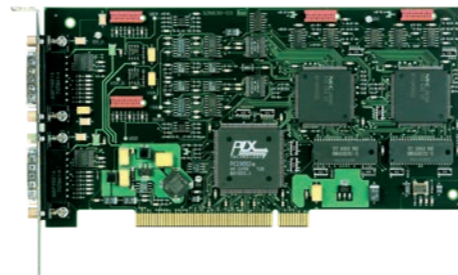

The IK 220 signal converter is an evaluation unit for two axes. As a PC counter card, the IK 220 can be inserted directly into a free PCI slot on the computer.

Design

Connectable to the IK 220 are two HEIDENHAIN encoders with sinusoidal current signals ($\sim 11 \mu\text{App}$), sinusoidal voltage signals ($\sim 1 \text{Vpp}$), or an EnDat 2.1 or SSI interface. External latch inputs/outputs and the output of encoder signals ($\sim 11 \mu\text{App}$) can be implemented by means of additional slot covers (accessory).

Functions

The IK 220 subdivides the signal periods of the sinusoidal encoder signals up to 4096-fold. The signals are called and stored through either external latch inputs or software.

The IK 220 features an integrated **measured value memory**. A total of up to 8192 measured values can be stored in the buffer memory and can be output as a single block.

Further processing of the measured values in the PC is performed by operator-created programs. To demonstrate the possibilities of the PC counter card, example programs and a software driver are included in delivery.

Basic circuit diagram

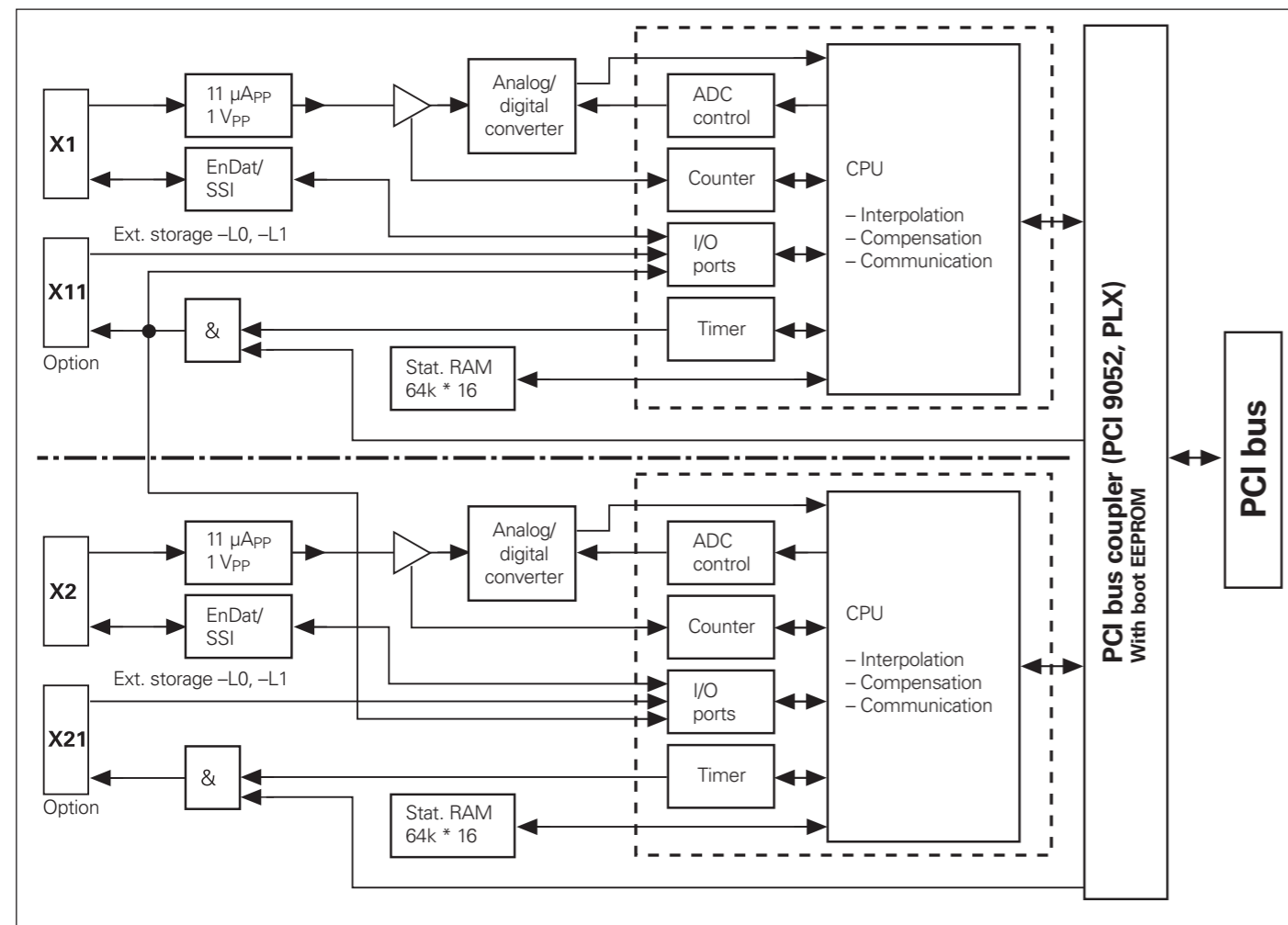

IK 220					
Encoder inputs	15-pin D-sub connections (male, X1 and X2), for two encoders				
Input signals (switchable)	<table border="1"> <tr> <td>$\sim 1 \text{Vpp}$</td> <td>$\sim 11 \mu\text{App}$</td> <td>EnDat 2.1</td> <td>SSI</td> </tr> </table>	$\sim 1 \text{Vpp}$	$\sim 11 \mu\text{App}$	EnDat 2.1	SSI
$\sim 1 \text{Vpp}$	$\sim 11 \mu\text{App}$	EnDat 2.1	SSI		
Input frequency	<table border="1"> <tr> <td>$\leq 500 \text{ kHz}$</td> <td>$\leq 33 \text{ kHz}$</td> <td colspan="2">-</td> </tr> </table>	$\leq 500 \text{ kHz}$	$\leq 33 \text{ kHz}$	-	
$\leq 500 \text{ kHz}$	$\leq 33 \text{ kHz}$	-			
Cable length ¹⁾	<table border="1"> <tr> <td>$\leq 60 \text{ m}$</td> <td colspan="3">$\leq 10 \text{ m}$</td> </tr> </table>	$\leq 60 \text{ m}$	$\leq 10 \text{ m}$		
$\leq 60 \text{ m}$	$\leq 10 \text{ m}$				
Adjustment of encoder signals	Adjustment of offset, phase and amplitude by the software				
Signal subdivision	4096-fold				
Data register for measured values	48 bits; of which only 44 bits are used for the measured value				
Internal memory	For 8192 position values				
Measured-value trigger	Through the following (selectable): <ul style="list-style-type: none"> External latch signals (over separate IK assembly for external inputs/outputs) Software command Timers Traversing of reference marks 				
Access time to measured values	<ul style="list-style-type: none"> Without adjustment, without compensation run: $\leq 100 \mu\text{s}$ With adjustment, without compensation run: $\leq 110 \mu\text{s}$ With adjustment, with compensation run: $\leq 160 \mu\text{s}$ 				
Interface	PCI bus (plug and play) Local Bus Specification Rev. 2.1				
Driver software and demonstration program	For Windows 7 (32-bit and 64-bit) In VISUAL C++, VISUAL BASIC, and BORLAND DELPHI included in delivery Via download: Windows 10 (64-bit)				
Outputs for encoder signals	$\sim 11 \mu\text{App}$ Via PCB connector on the IK (10-pin, female) Fitting cable assembly with PC-slot cover optionally available				
Power consumption	$\approx 4 \text{ W}$, without encoders				
Dimensions	190 mm x 100 mm				
Operating temperature	0 °C to 55 °C (storage temperature: -30 °C to 70 °C)				

¹⁾ With HEIDENHAIN cable; longer cable lengths upon request

Mounting

Mounting the GAGE-CHEK 2000

With the Multi-Pos or Duo-Pos stand, the GAGE-CHEK 2000 evaluation units can be set up at different angles of tilt. Mounting to the machine can be accomplished with the Multi-Pos holder or with other fastening systems featuring a 50 mm x 50 mm hole pattern.

Multi-Pos stand

For setup on and fastening to a horizontal surface (90° continuous tilt range).

ID 1089230-07



GAGE-CHEK 2000
with Multi-Pos stand

Single-Pos stand

Included in delivery.
For setup on and fastening to a surface (20° tilt).

ID 1089230-05

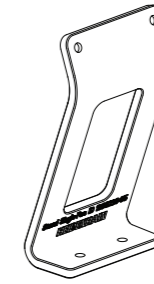

Duo-Pos stand

For setup on and fastening to a horizontal surface (20° or 45° tilt).

ID 1089230-06

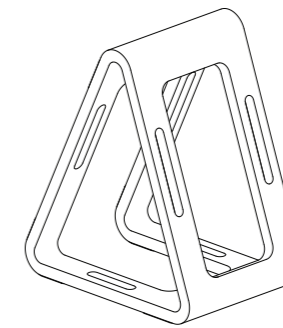

Multi-Pos holder

For fastening to an arm (90° continuous tilt range).

ID 1089230-08

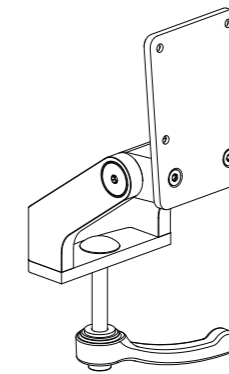

Mounting arm, straight

For fastening to a machine.

ID 1089207-01

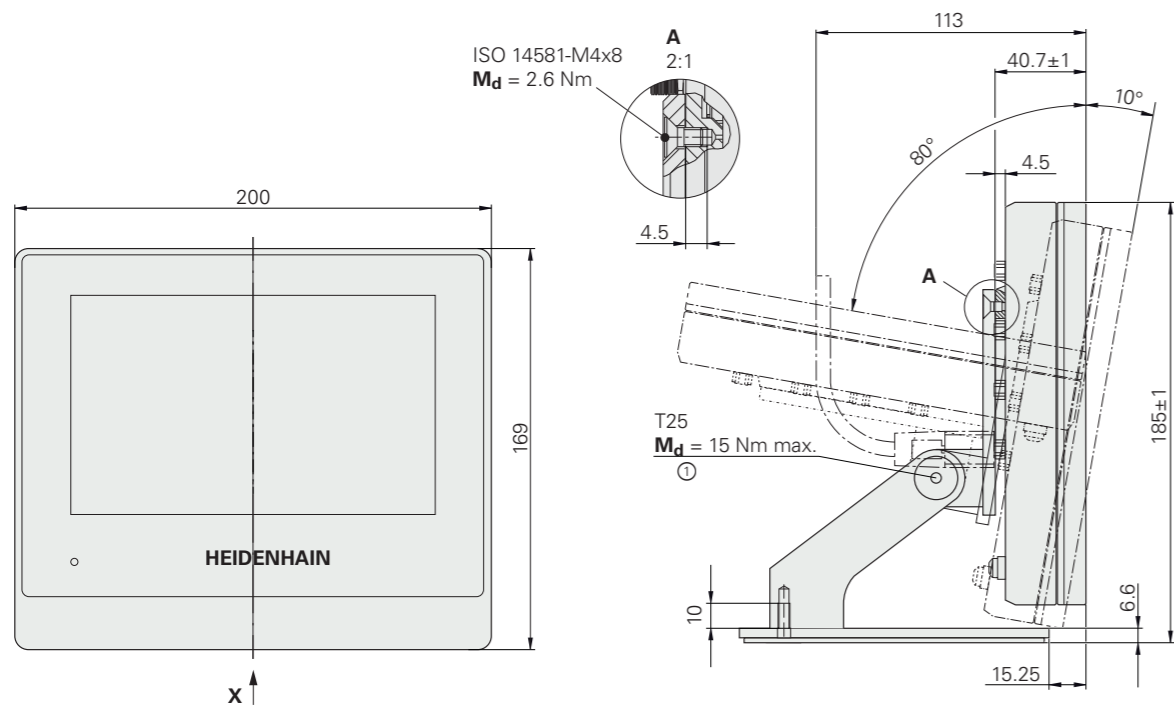
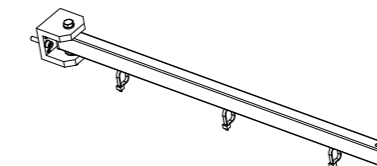

1 = Recommended tightening torque: $M_d = 6.8 \text{ Nm}$

mm
Tolerancing ISO 8015
ISO 2768:1989-mH
≤ 6 mm: ±0.2 mm

Accessory: adapter connectors

Adapter connectors for the GAGE-CHEK 2000

For pin-layout conversion from HEIDENHAIN TTL to RSF TTL and Renishaw TTL.
ID 1089210-01

For pin-layout conversion from HEIDENHAIN 11 μ APP to HEIDENHAIN 11 μ APP.
ID 1089213-01

For pin-layout conversion from HEIDENHAIN 1 V_{PP} to HEIDENHAIN 1 V_{PP}.
ID 1089214-01

For pin-layout conversion from HEIDENHAIN 1 V_{PP} to Mitutoyo 2 V_{PP}.
ID 1089216-01

Adapter cable for the GAGE-CHEK 2000

For pin-layout conversion from the HEIDENHAIN touch-probe interface to the Renishaw touch-probe interface.
ID 1095709-xx



TTL adapter connector



11 μ APP 1 V_{PP} 2 V_{PP} adapter connector

Accessory: external operating element

Although the evaluation units are easy and intuitive to operate, external control capability may be useful in certain scenarios. The foot switch is used for externally controlled operation:

Foot switch (accessory)
Cable length: 2.4 m

For GAGE-CHEK 2000, with a 15-pin D-sub connector and two keys.
ID 681041-04



Foot switch

Mounting the ND 200

ND 200 series

The ND 200 series digital readouts were designed as benchtop units and can be easily stacked. Recesses on the top prevent the stacked units from shifting out of place.

Through threaded holes at the bottom, the ND 28x can be fastened to a base plate with M4 screws.

Two side-by-side ND 28x readouts fit inside a 19-inch housing. For mounting inside a 19-inch housing, a mounting adapter is available as an accessory.

Accessories

Mounting adapter for 19-inch housing
ID 654020-01



ND 287

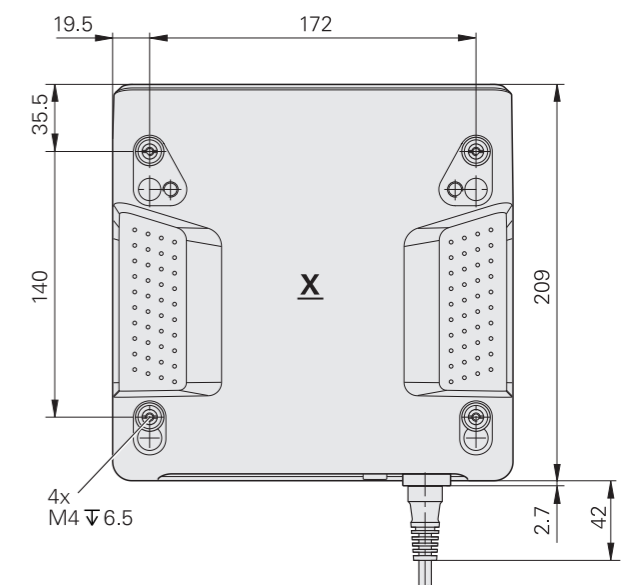
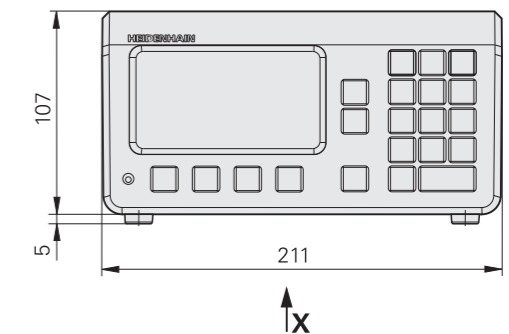
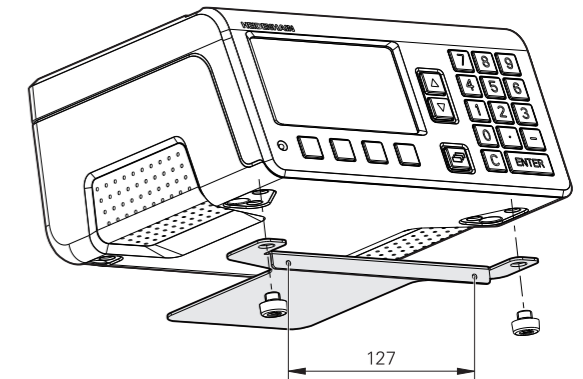

mm
Tolerancing ISO 8015
ISO 2768:1989-mH
≤ 6 mm: ±0.2 mm

Mounting the EIB 700

The EIB 700 series was designed as a benchtop unit. It must be installed in a well-ventilated area and at a specified operating orientation.

Through threaded holes at the bottom, the EIB 700 can be fastened to a base plate with M3 screws. Two side-by-side EIB 700 units fit next to each other in a 19-inch housing, thus occupying one height unit. A mounting bracket is available as an accessory.

Accessories

Mounting bracket

For installation of two EIB 74x units in a 19-inch housing.
ID 671144-01

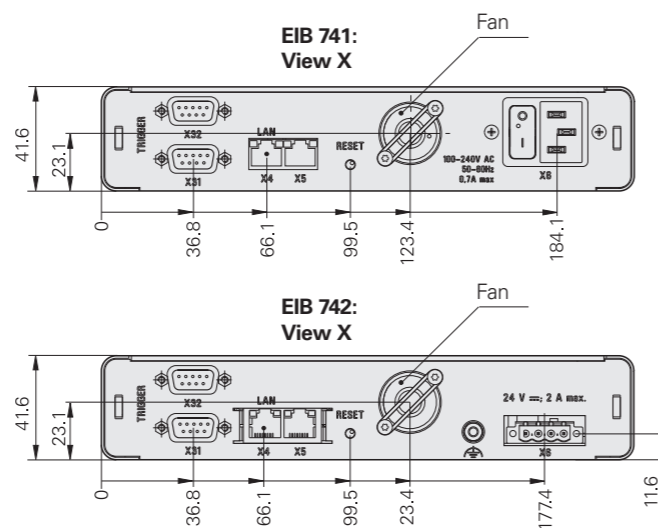
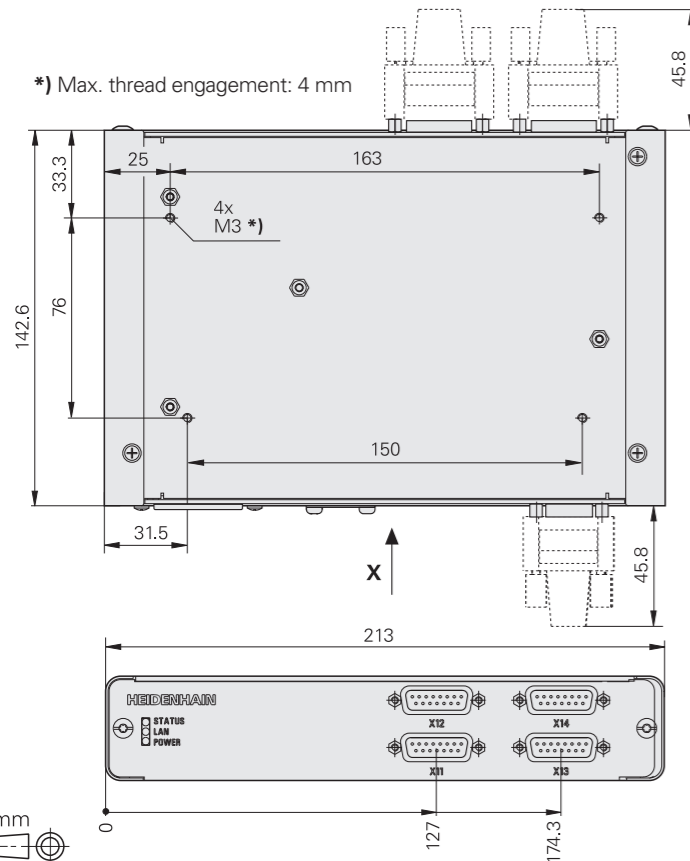
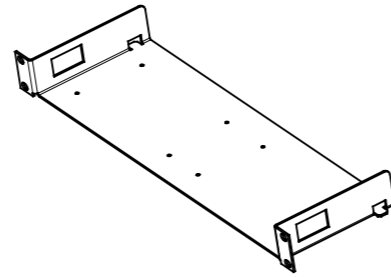

mm
Tolerancing ISO 8015
ISO 2768:1989-mH
≤ 6 mm: ±0.2 mm

Interfaces

Evaluation units with an integrated display

The evaluation units are equipped with interfaces for encoders, communication, and external components.



	GAGE-CHEK 2013 GAGE-CHEK 2023 GAGE-CHEK 2093	GAGE-CHEK 2013 I/O	ND 280	ND 287
Encoders				
1 V _{PP} /11 μA _{PP}	✓	✓	✓	✓
TTL	✓	–	–	–
EnDat 2.2 ¹⁾	✓	✓	✓	✓
Touch probe	✓ ²⁾	✓ ²⁾	–	–
Sensor	–	Input: 0 V to 5 V Output: ±10 V	–	Option: ±10 V
Data				
USB	Type A	Type A	Type B	Type B
RS-232-C/V.24	✓ ³⁾	✓ ³⁾	✓	✓
Ethernet	✓	✓	–	Option
Foot switch	✓	✓	–	–
Switching outputs	1 TTL	1 TTL 8 DC 24 V	–	6 TTL
Switching inputs	4 TTL	4 TTL 24 High DC 11 V to 30 V Low DC 3 V to 2.2 V	–	12 TTL

¹⁾ Purely serial, with no evaluation of incremental signals

²⁾ HEIDENHAIN or Renishaw touch probe

³⁾ Possible with RS-232 adapter connection via USB port

Optional assemblies for the ND 287

Various input and output assemblies are available for the evaluation unit.

Second encoder input (option)

The ND 287 evaluation unit can be equipped with an optional second encoder input.

Encoder module

Input assembly for second encoder with a 1 V_{PP}, 11 μA_{PP}, or EnDat 2.2 interface. ID 654017-01

Analog input (option)

Through an optional input assembly, the ND 287 evaluation unit can be equipped with an additional analog input for connecting a sensor. The input voltage range is interpolated 4096-fold; for a sensor with ±10 V, the resolution is therefore 5 mV. The analog module provides DC 5 V, DC 12 V, and DC 24 V as supply voltage for the sensor.

The DC 5 V (B) and DC 12/24 V (A) supply voltages are galvanically isolated and must not be used at the same time. A 9-pin D-sub connector is required as a mating connector.

Analog module

Input assembly for ±10 V analog sensor ID 654018-01

Ethernet (option)

The ND 287 evaluation unit can be provided with an optional Ethernet module.

Ethernet module

ID 654019-01

This module features an Ethernet 100BaseT interface with an RJ45 connector (8-pin, female), allowing the ND 287 to be connected directly to an internal network or, with a crossover cable, to a PC.

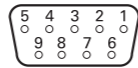

Pin	Assignment
1	-12 V (A)/85 mA
2	0 V (A)
3	0 V (A)
4	+12 V (A)/85 mA
5	Shield
6	0 V (B)
7	0 V (B)
8	Sensor (B) max. ±10 V
9	+5 V (B)/400 mA

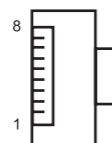

Pin	Assignment
1	TX+
2	TX-
3	REC+
4	Do not assign
5	Do not assign
6	REC-
7	Do not assign
8	Do not assign
Housing	External shield

Switching inputs/outputs on the ND 287

Switching inputs

The ND 287 evaluation unit features numerous inputs for external operation and outputs for switching functions. The inputs can be addressed with a pulse or a closed contact.

Exception: the switching inputs for transmitting measured values over the data interface are separate for contact and pulse.

The switching input E is active when a LOW signal U_L is applied (contact or pulse to 0V).

Signal level

-0.5V ≤ U_L ≤ 0.9V with I_L ≤ 6 mA
3.9V ≤ U_H ≤ 15.0V
t_{min} ≥ 30 ms

Zero reset / set value

Via an external signal, each axis can be set to the display value zero or to a value stored in a parameter (SET).

External control of measurement series Switching the display to MIN, MAX, and DIFF

Continuously applying a LOW signal at the corresponding switching input activates the external operation of measurement series. The start of a new measurement series and the switch to the MIN/MAX/DIFF display are then externally controlled through further switching inputs.

Ignoring reference mark signals (reference pulse lock)

When this input is active, the readout ignores all of the reference mark signals. A typical application for this is when linear measurement is performed with a rotary encoder and a lead screw.

Activating or deactivating REF mode

After switch-on or a power interruption, the digital readout can be externally switched to REF mode. The next signal then deactivates REF mode (switching function).

Display with axis coupling

The ND 287 can have two optional encoder inputs. Using switching inputs, you can switch the display to individual measured values, a sum, a difference, or any logical operation.

	ND 287
Twelve switching inputs	Zero reset, clear error message Set a preset Ext. control of measurement series or display X1 ¹⁾ Start measurement series or display f (X1, X2) ¹⁾ Display minimum MIN or display X2 ¹⁾ Display maximum MAX or display X1 + X2 ¹⁾ Display difference DIFF or display X1 - X2 ¹⁾ Measured value output (pulse) Measured value output (contact) Ignore reference mark signals (input X1) Ignore reference mark signals (input X2) Activate or deactivate REF mode
Six switching outputs	Display value is "0" Measured value ≥ Switching limit A1 Measured value ≥ Switching limit A2 Measured value > Upper sorting limit Measured value < Lower sorting limit Error

¹⁾ Also selectable by parameter

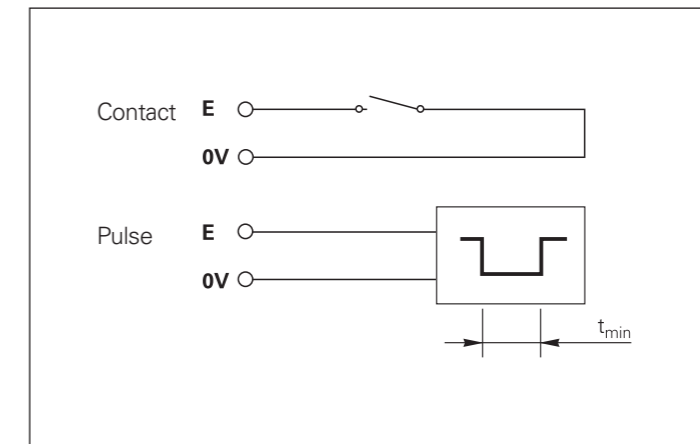

EIB 700 and IK 220 signal converters

Switching outputs

The ND 287 features open-collector outputs that switch to 0 V (= Active LOW).

Delay until signal output:

$t_v \leq 20 \text{ ms}$

Signal level

$U_L \leq 0.4 \text{ V}$ with $I_L \leq 100 \text{ mA}$
 $U_H \leq 32 \text{ V}$ with $I_H \leq 10 \mu\text{A}$

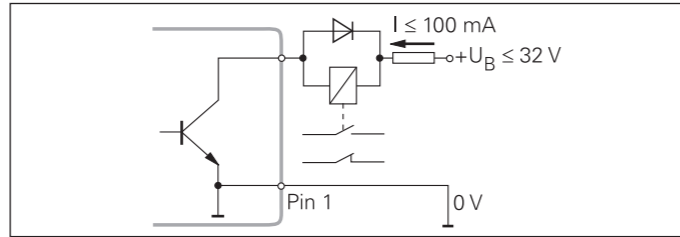

Trigger points (actual value mode)

When the measured value reaches trigger points defined via parameters, the corresponding output becomes active. Up to two trigger points can be defined.

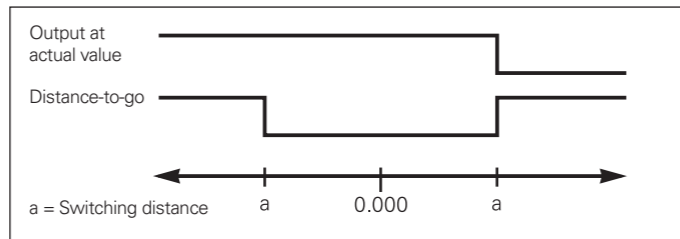

Switch-off ranges (distance-to-go mode)

In distance-to-go mode, the trigger points function as switch-off ranges, appearing equidistantly from the display value "0".

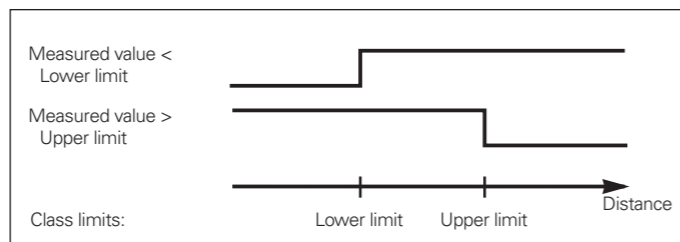

Sorting limits

When the tolerance sorting limits as defined via parameters are exceeded, the corresponding outputs become active.

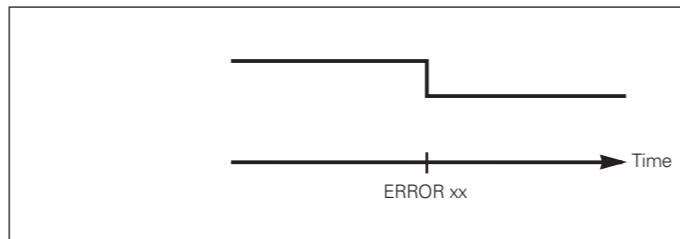

Triggering signal for an error

The ND 200 readouts constantly monitor the measuring signals, input frequency, data output, etc., displaying error messages as they arise. If errors occur that have a significant effect on a measurement or data output, the readout sets a switching output to active. This enables monitoring for automated processes.

Zero crossover

At the display value "0", the corresponding output becomes active. The minimum signal duration is 180 ms.

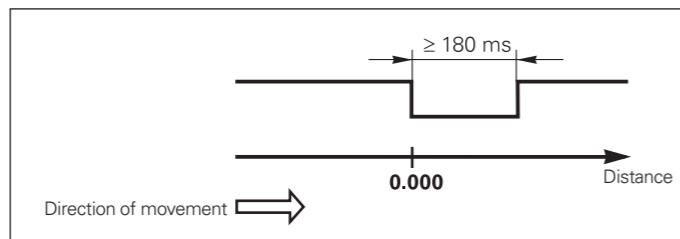

The EIB 700 and IK 220 units feature D-sub connectors for external operation and the connection of encoders.

With the IK 220, the encoder signals can be routed out over an additional slot cover and are available as 11 μA current signals for further processing in evaluation electronics or EXE pulse-shaping electronics. A further slot cover contains the connections for the external inputs/outputs (e.g., for storing the measured values).

	EIB 700	IK 220
Encoder inputs		
1 V _{PP}	4 ¹⁾	2 ¹⁾
11 μA_{PP}	4 ¹⁾	2 ¹⁾
EnDat 2.1	4 ¹⁾	2 ¹⁾
EnDat 2.2	4 ¹⁾	–
SSI	–	2 ¹⁾
Encoder outputs		
11 μA_{PP}	–	2 (optional assembly)
Trigger input	4	2 (optional assembly)
Trigger output	4	2 (optional assembly)
Logic inputs/outputs	4/4 ²⁾	2/–

¹⁾ Selectable

²⁾ Can also be used as a trigger, or as a logic input or output

Accessories

External inputs/outputs for the IK 220
Slot cover with two 9-pin D-sub connections (male).
ID 340253-01

Output assembly for the IK 220
Slot cover with two 9-pin D-sub connections (male), for forwarding the encoder signals (11 μ A_{pp}) to the downstream electronics.
ID 340252-01

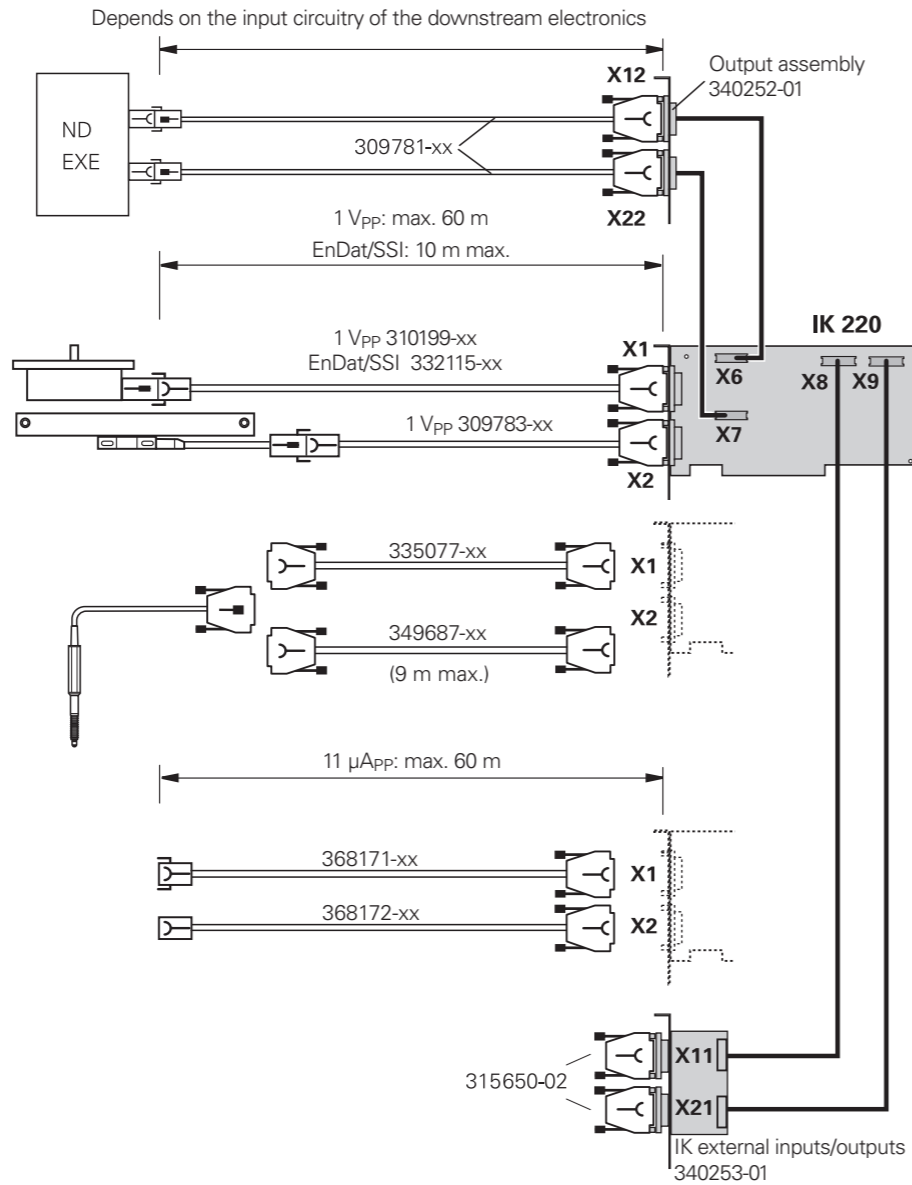

EIB application software for the EIB 700

The EIB application software covers two applications:

Configuring and demonstrating the EIB 700

- Easy configuration of settings required for operating the EIB 700 (e.g., input interface, data packets, operating mode, trigger settings)
- Management of one or more EIB 700 units
- Simple depiction of the positions transmitted by the EIB 700
- Saving of settings for management of different application projects

For more information, please refer to the User's Guide.

Platform for customized applications

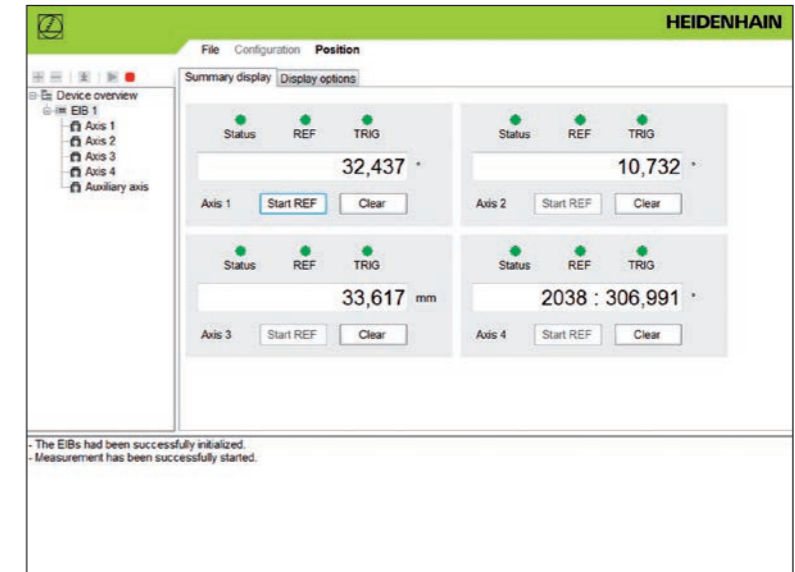

The EIB application software is provided as source code, thereby allowing customers to rapidly implement their own applications. The application software was programmed using C++/CLI and Windows Forms in Visual Studio 2008. This programming environment is widely used in technical application programming but does not necessarily provide state-of-the-art user interfaces such as those in Windows 10. However, adaptation to other graphical interfaces can be performed by the customer.



Encoder inputs

The evaluation electronics are equipped with interfaces for connecting HEIDENHAIN encoders. Other interfaces are available upon request.

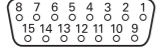
Pin layout for $\sim 1V_{PP}$



15-pin D-sub flange socket (female)														
														
	Power supply				Incremental signals						Others			
	4	12	2	10	1	9	3	11	14	7	5/6/8/13/15			
$\sim 1V_{PP}$	U_P	Sensor U_P	0V	Sensor 0V	A+	A-	B+	B-	R+	R-	/			
$\sim 11\mu A_{PP}$	●		●								Internal shield			

Cable shield connected to housing; U_P = Power supply voltage

Sensor: The sense line is connected in the encoder with the corresponding power line.

Vacant pins or wires must not be used.

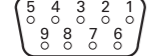

Pin layout for \square TTL

9-pin D-sub flange socket (female)									
									
	Power supply		Incremental signals						Others
	7	6	2	3	4	5	9	8	1
\square TTL	U_P	0V	U_{a1}	$\overline{U_{a1}}$	U_{a2}	$\overline{U_{a2}}$	U_{a0}	\square	/

Cable shield connected to housing; U_P = Power supply voltage

Vacant pins or wires must not be used.

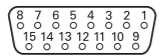
Pin layout of the ND 200 and GAGE-CHEK series with $\sim 1V_{PP}/\sim 11\mu A_{PP}/EnDat$



15-pin D-sub flange socket (female)															
															
	Power supply				Incremental signals						Serial data transfer				
	4	12	2	10	6	1	9	3	11	14	7	5	13	8	15
$\sim 1V_{PP}$	U_P	Sensor U_P	0V	Sensor 0V	/	A+	A-	B+	B-	R+	R-	/	/	/	/
$\sim 11\mu A_{PP}$	●		●		Internal shield							/			
EnDat						/	/	/	/	/	/	/	DATA	DATA	CLOCK

Shield lies on housing; U_P = Power supply voltage

Sensor: The sense line is connected in the encoder with the corresponding power line.

Vacant pins or wires must not be used!

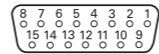
Pin layout of the EIB 700 series with $\sim 1V_{PP}$

15-pin D-sub flange socket (female)															
															
	Power supply				Incremental signals						Others				
	4	12	2	10	6	1	9	3	11	14	7	8	6	5/13/15	
$\sim 1V_{PP}$	U_P	Sensor U_P	0V	Sensor 0V	/	A+	A-	B+	B-	R+	R-	L1/H ¹⁾	L2/L ¹⁾	/	
$\sim 11\mu A_{PP}$	●		●		Internal shield							/			



Shield lies on housing; U_P = Power supply voltage

Sensor: The sense line is connected in the encoder with the corresponding power line.

Vacant pins or wires must not be used!

¹⁾ Pins for homing or limit signals if supported by the encoder

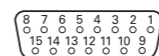
Pin layout of the EIB 700 series with EnDat

15-pin D-sub flange socket (female)															
															
	Power supply				Incremental signals ¹⁾				Serial data transfer				Others		
	4	12	2	10	6	1	9	3	11	5	13	8	15	7/14	
EnDat	U_P	Sensor U_P	0V	Sensor 0V	Internal shield	A+	A-	B+	B-	DATA	DATA	CLOCK	CLOCK	/	
	●		●		Internal shield							/			



Shield lies on housing; U_P = Power supply voltage

Sensor: The sense line is connected in the encoder with the corresponding power line.

Vacant pins or wires must not be used!

¹⁾ For encoders with ordering designations EnDat01 and EnDat02

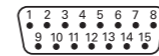
Pin layout of the IK 220

15-pin D-sub flange socket (male)															
															
	Power supply				Incremental signals						Serial data transfer				
	1	9	2	11	13	3	4	6	7	10	12	5	8	14	15
$\sim 11\mu A_{PP}$	U_P	Sensor 5V	U_N	Sensor 0V	Internal shield	I ₁₊	I ₁₋	I ₂₊	I ₂₋	I ₀₊	I ₀₋	/	/	/	/
$\sim 1V_{PP}$	●		●		Internal shield							/			
EnDat SSI						/	/	/	/	/	/	/	DATA	DATA	CLOCK

Shield on connector housing

Vacant pins or wires must not be used!

HEIDENHAIN

Mastering nanometer accuracy



HEIDENHAIN

DR. JOHANNES HEIDENHAIN GmbH
Dr.-Johannes-Heidenhain-Straße 5
83301 Traunreut, Germany
☎ +49 8669 31-0
☎ +49 8669 32-5061
info@heidenhain.de
www.heidenhain.com



HEIDENHAIN
worldwide